

Species diversity of yeasts in the northern and southern areas of Japan

**Masako Takashima^{1*}, Takashi Sugita²,
Kwang-Deuk An¹, Moriya Ohkuma¹**

¹*Microbe Division/Japan Collection of Microorganisms (JCM), RIKEN BioResource Center, Wako, Saitama 351-0198*

²*Department of Microbiology, Meiji Pharmaceutical University, Kiyose, Tokyo 204-8588, Japan*

*E-mail: masako@jcm.riken.jp



Mt Rishiri from Hime-numa marsh at Rishiri Island



Nakama River and mangrove on Iriomote Island

Subject



Japan consists of four large islands and many others that form a line from northeast to southwest, approximately $45^{\circ}\text{N}148^{\circ}\text{E}$ to $24^{\circ}\text{N}122^{\circ}\text{E}$. The northern part belongs to the subarctic zone and the southern part to the subtropical zone, so that Japan is rich in biodiversity.

In this study, our tasks are:

- 1) to investigate and compare the species diversity of yeasts between these areas and**
- 2) to contribute to the construction of an inventory of microorganisms in Japan**

This study was partially supported by a research grant from the Institute for Fermentation, Osaka (IFO).



Location of Iriomote Island and Rishiri Island



**Rishiri Island in
the Rishiri, Rebun, Sarobetsu National Park
Sampling: Aug. 2007 & Sep. 2008**

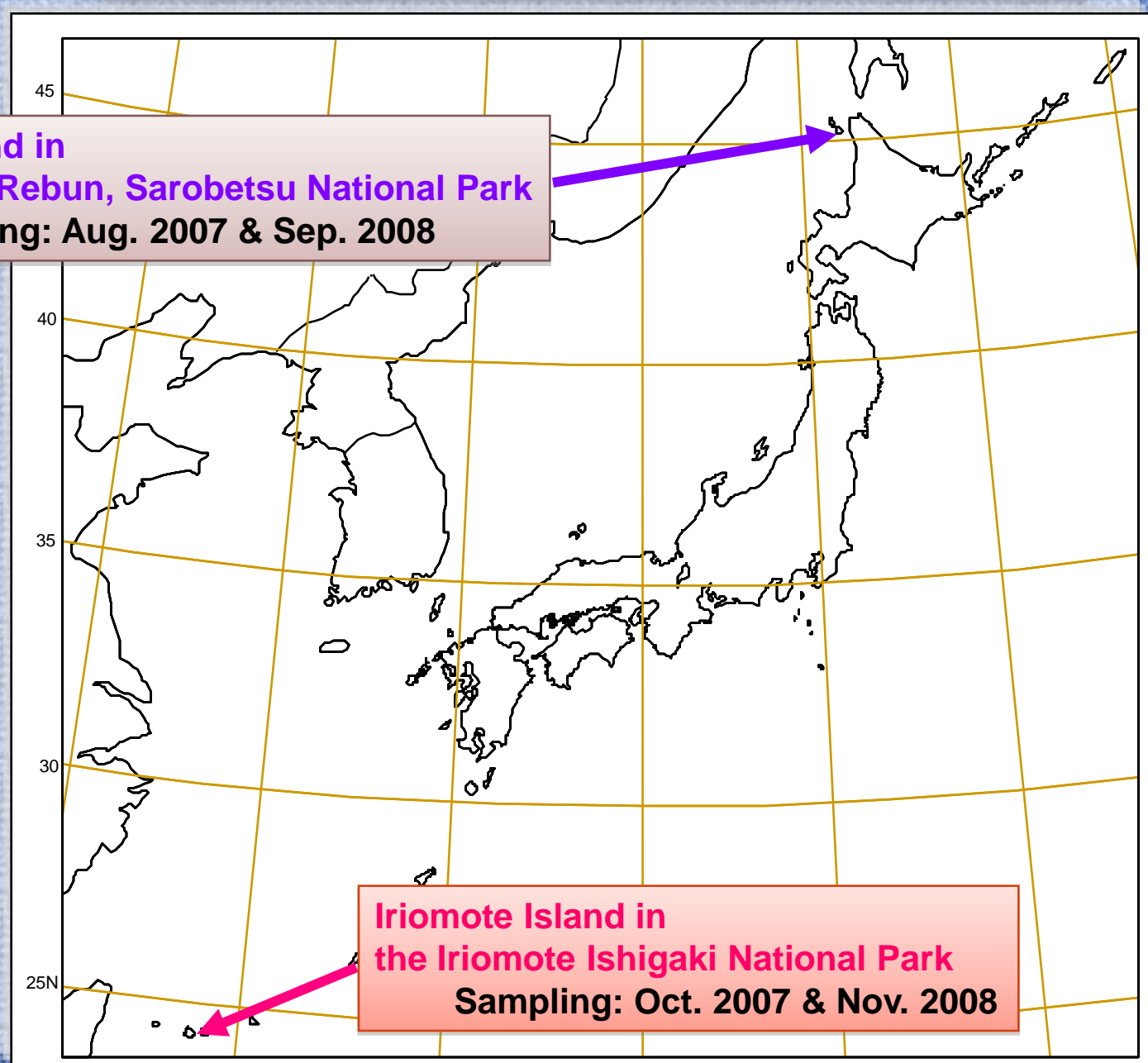

**Iriomote Island in
the Iriomote Ishigaki National Park
Sampling: Oct. 2007 & Nov. 2008**

Isolation and tentative identification

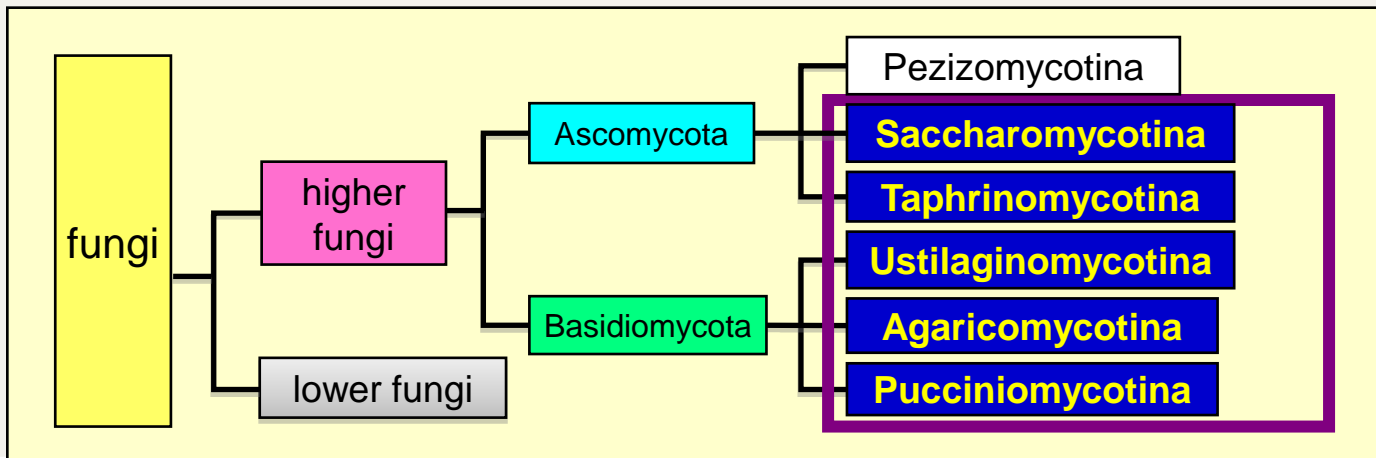
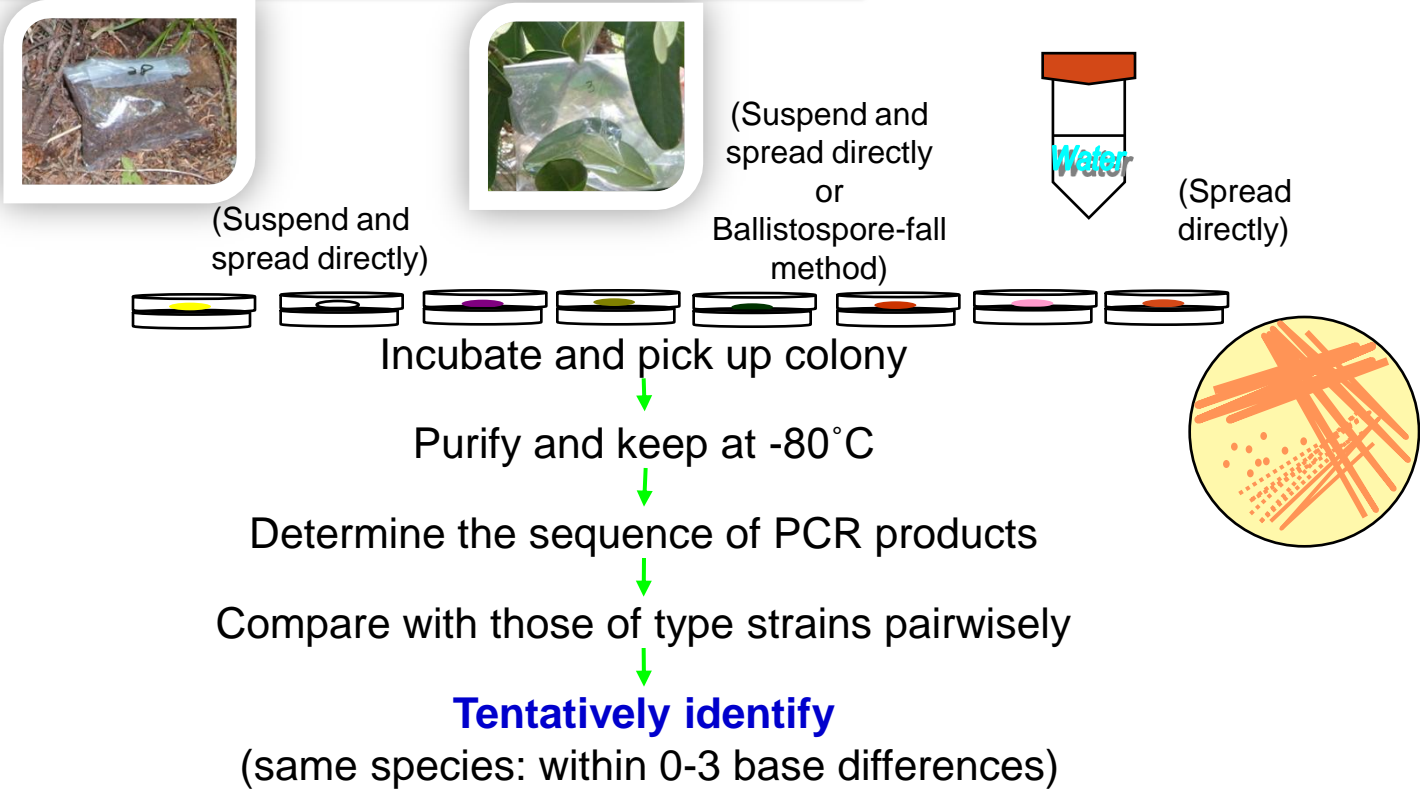

Number of species in “The Yeasts, A Taxonomic Study”

	4th ed. (Kurtzman & Fell, 1998)*		5th ed. (will be published in 2010)**		Number of species described
	Teleomorph	Anamorph	Teleomorph	Anamorph	
Ascomycetous yeasts	45 genera 270 species 19 varieties	15 genera 230 species 4 varieties	72 genera	14 genera	1000 species (Kurtzman & Fell, 2006)
Basidiomycetous yeasts	19 genera 51 species 1 variety	21 genera 171 species 1 variety	34 genera	28 genera	more than 500 species (Boekhout, personal communication)

*, including the duplication due to teleomorph-anamorph relationship

** , estimated data from the table of contents sent by the Publisher of "The Yeasts, A Taxonomic Study" 5th ed.

The number of described species is increasing!

Bacteria & Archaea :

500-600 species / year

Yeasts (from Index of Fungi):

79 species (2008)

Yeasts isolated from Iriomote Island and Rishiri Island

Total: 901 strains 177 species (103 new species candidates)
including shared species

Iriomote Island			Rishiri Island		
Strains	Species	New species candidates	Strains	Species	New species candidates
428	99	58 (59%)	473	92	47 (51%)

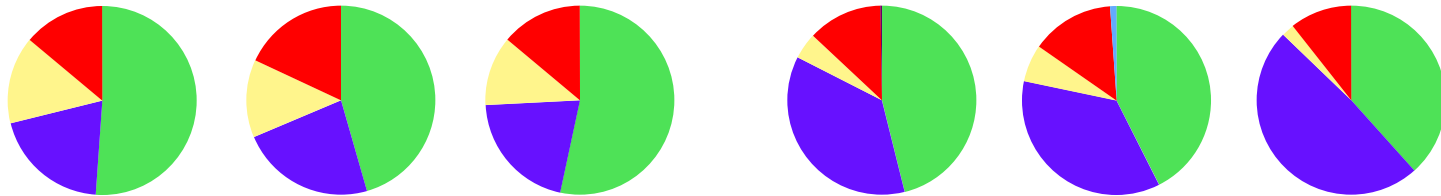

Ascomycetous yeasts: ■ Taphrinomycotina ■ Saccharomycotina
Basidiomycetous yeasts: ■ Ustilaginomycotina ■ Agaricomycotina ■ Pucciniomycotina

The number of species isolated (177) in this project accounts for 12% of the number of species in “The Yeasts, A Taxonomic Study, 5th ed.”, which will be published shortly (around 1500 species). Furthermore, the number of our new species candidates is around 7% of the total species described to date.

Common species between Iriomote Island and Rishiri Island

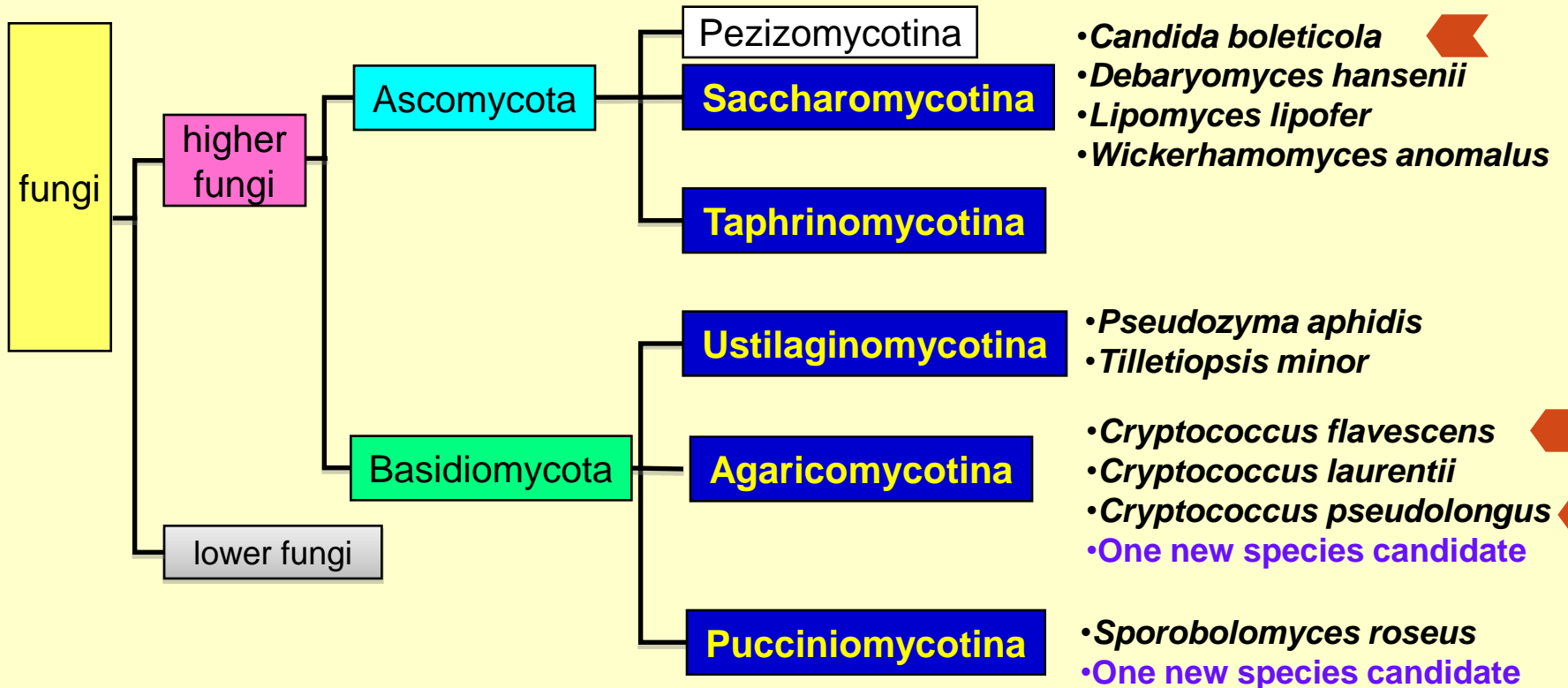

10 common species / 177 species isolated = 5.6% !!

Species level: Commonality with other areas

Iriomote Island: southern part

- *Kazachstania yakushimaensis* (isolated from Yakushima, Kyushu, Japan)
- *Sporobolomyces ogasawarensis* (isolated from the Ogasawara Islands, 1000 km south of Tokyo, Japan)
- *Rhodotorula bogoriensis* (isolated from Bogor, Indonesia)

Rishiri Island: northern part

- *Trichosporon porosum*
- *Cryptococcus terricola*
- *C. podzoricus*

(species reported so far from other areas of Japan, European countries and USA)

- Psychrophillic species: *Leucosporidium scottii*
(no *Udeniomyces* spp.)

Determination of richness

- A, Iriomote - Plant
- B, Iriomote - Soil
- C, Rishiri - Plant
- D, Rishiri - Soil

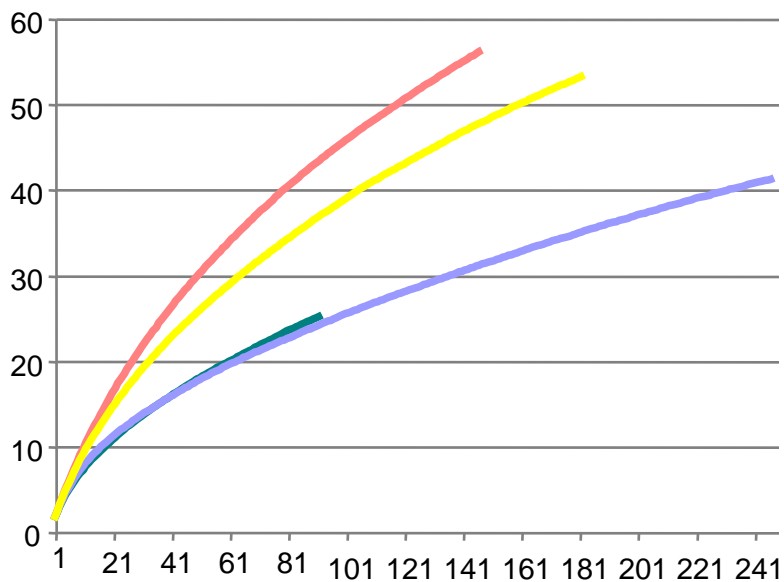

Distance 0.005

	chao	chao_lci	chao_hci
A	104	74.9	179.4
B	43.2	30.1	89.9
C	69.9	51.1	123.8
D	92	67.8	156.0

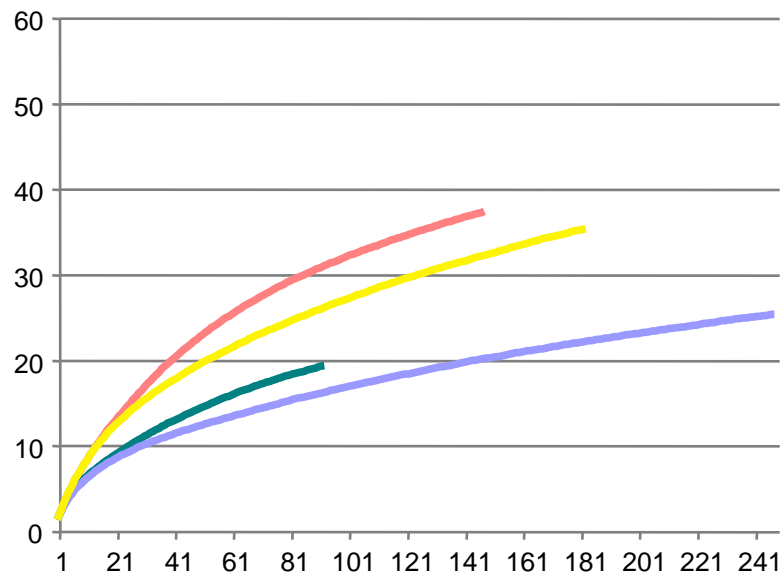

Distance 0.03

	chao	chao_lci	chao_hci
A	55.2	42.1	101.9
B	23.7	20.0	41.8
C	34.2	27.3	61.7
D	50	39.4	85.9

cf. *S. cerevisiae* - *S. pastourianus*, 2%;
S. cerevisiae - *Kazachstania* species, more than 3%

Richness details

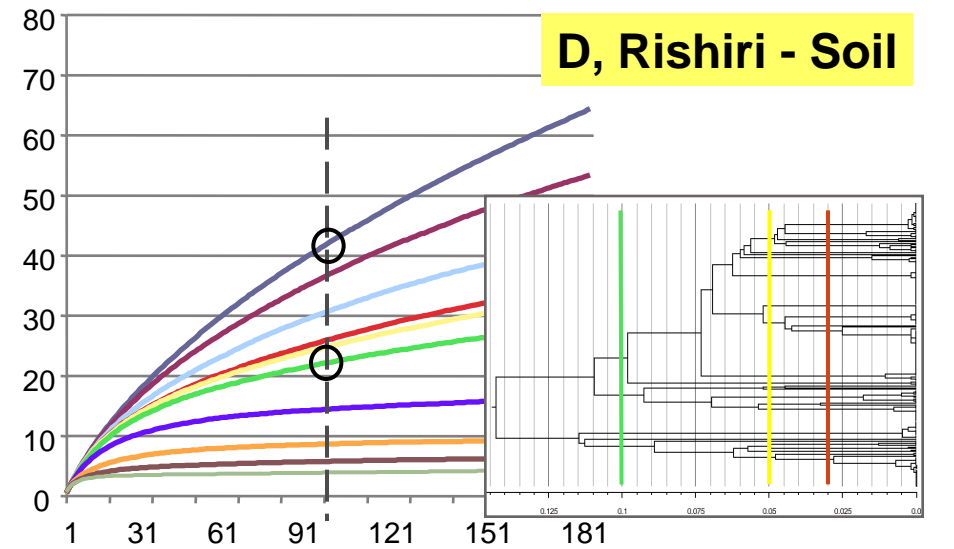
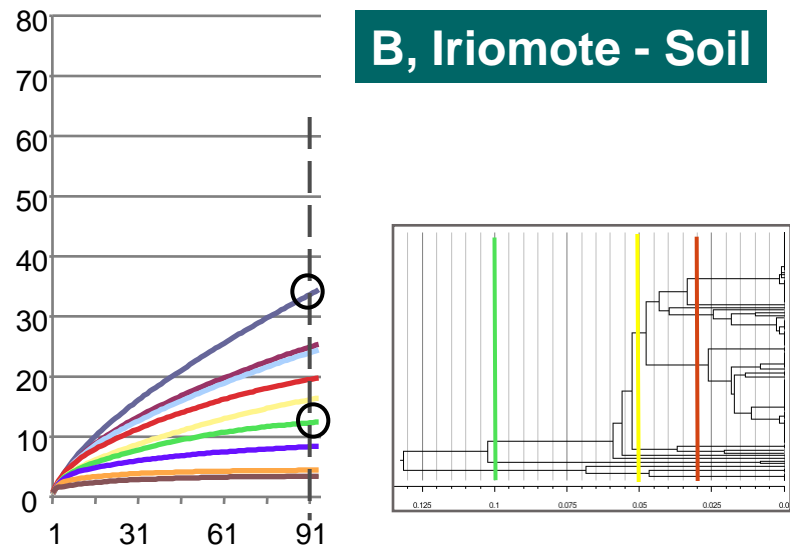
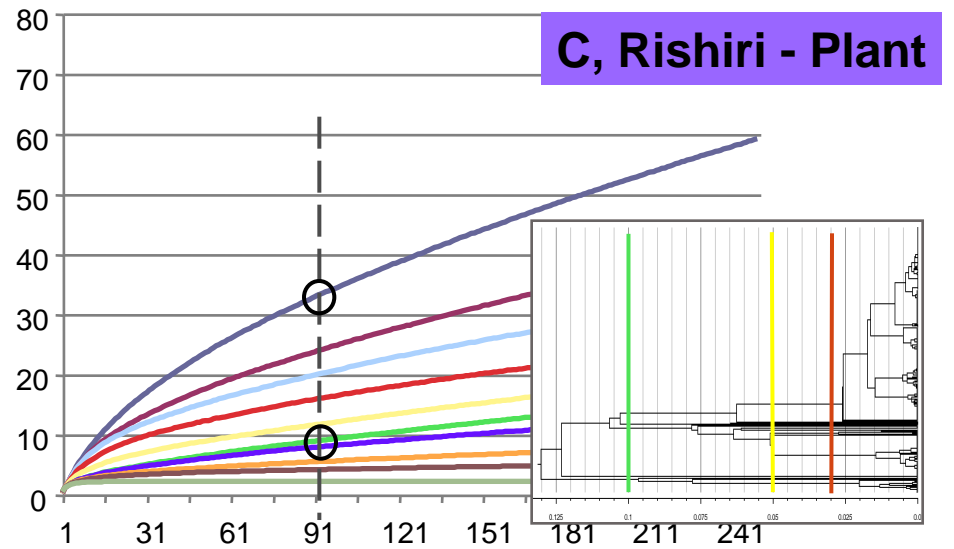
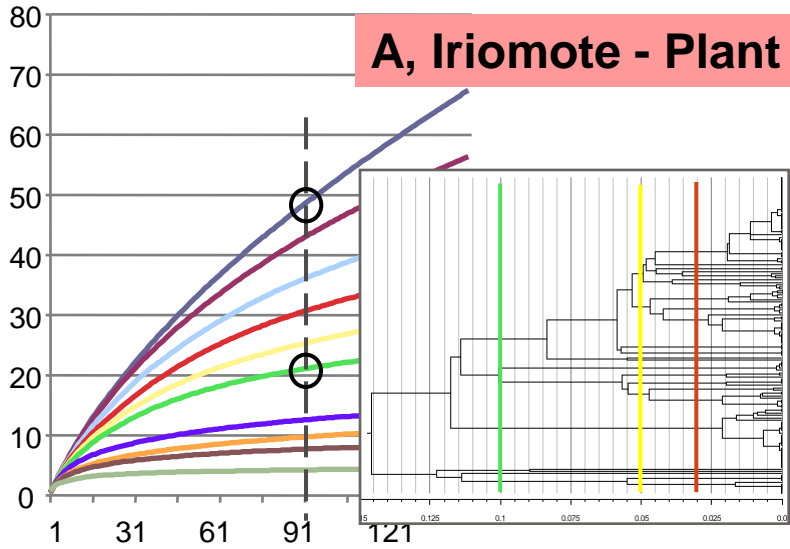
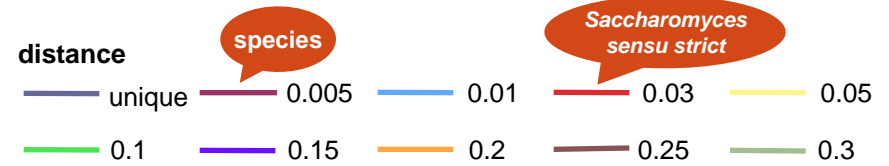

Strains isolated from:

- Iriomote - Plant
- Iriomote - Soil
- Rishiri - Plant
- Rishiri - Soil

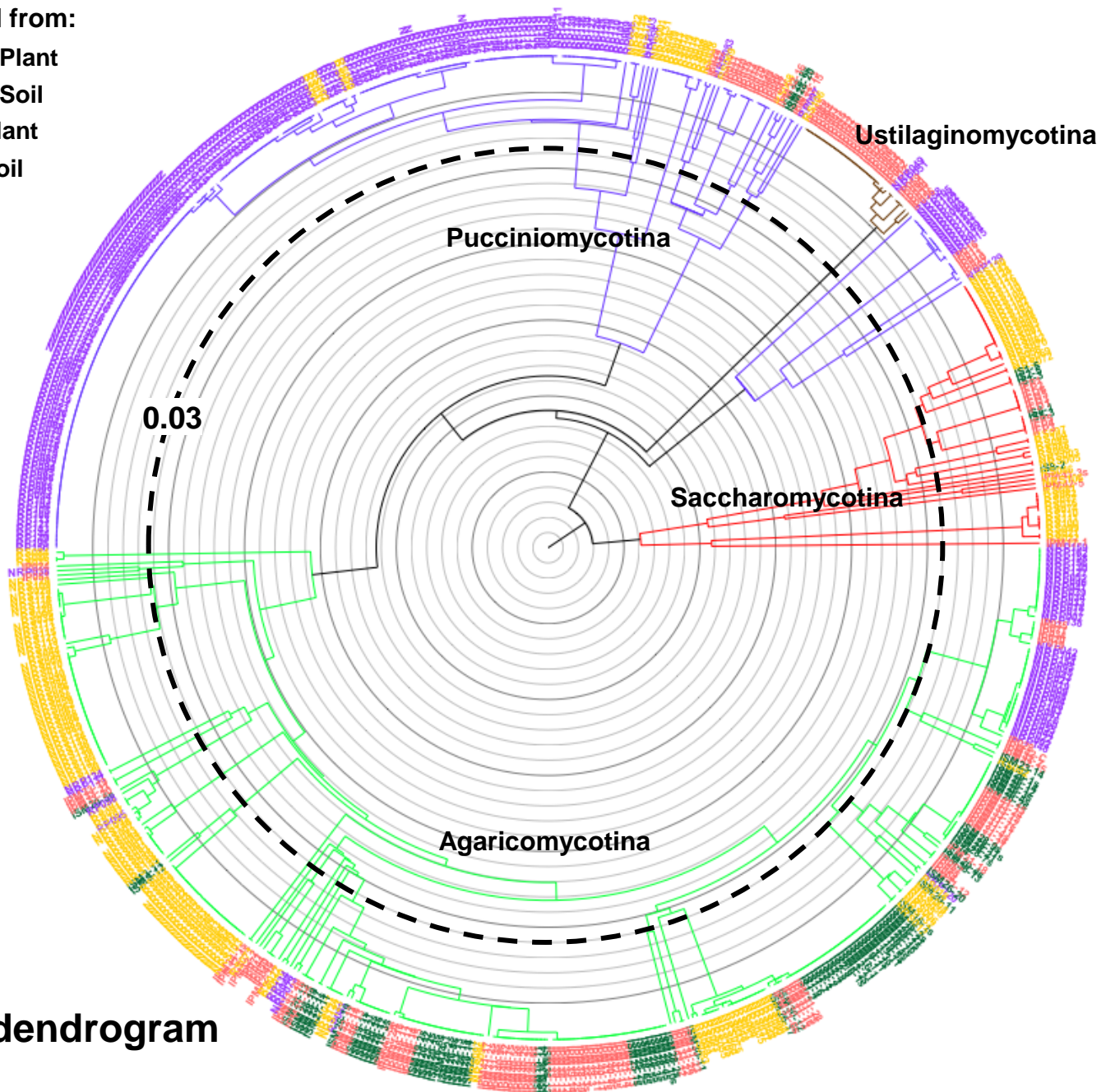

UPGMA dendrogram

Conclusion

- The number of species in this study accounted for 12% of those in “The Yeasts, A Taxonomic Study” 5th ed, which will be published this year (around 1500 species). Furthermore, around half of them were assumed to be new species. These results were obtained by only two samplings of each area, suggesting that more and more yeast species live in the environs of Japan, and needless to say, in the world.
- Common species isolated from Iriomote Island and Rishiri Island accounted for only 5.6% of those of isolated species. This indicates that each respective area has its own microbiota and statistical significance was also shown between them. This reveals anew the importance of the study of microbiota.
- A comprehensive reclassification of basidiomycetous yeasts is indispensable to discuss the species diversity in yeasts in an environment.
- To contribute to the making of an inventory of yeast species in Japan, we will continue to describe new species from our isolates after taxonomic study;
 - ✓ *Dioszegia rishiriensis* (accepted for publication in IJSEM)
 - ✓ 12 new species in the *Sporobolomyces roseus* cluster (to be submitted soon)